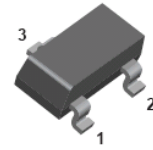

FEATURES

- For general AF application.
- Complementary PNP type available BC807.
- High collector current, high current gain.
- Low collector-emitter saturation voltage.

SOT-23

APPLICATIONS

- General purpose medium power amplifier.
- Switching requiring collector currents up to 1.2mA.

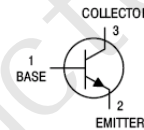

ORDERING INFORMATION

Type No.	Marking	Package Code
BC817-16	6A	SOT-23
BC817-25	6B	SOT-23
BC817-40	6C	SOT-23

MAXIMUM RATING @ Ta=25°C unless otherwise specified

Symbol	Parameter	Value	Unit
V_{CBO}	Collector-Base Voltage	50	V
V_{CEO}	Collector-Emitter Voltage	45	V
V_{EBO}	Emitter-Base Voltage	5	V
I_C	Collector Current -Continuous	500	mA
P_C	Collector Dissipation	300	mW
T_j, T_{stg}	Junction and Storage Temperature	-55to+150	°C

ELECTRICAL CHARACTERISTICS @ Ta=25°C unless otherwise specified

Parameter	Symbol	Test conditions	MIN	MAX	UNIT
Collector-base breakdown voltage	$V_{(BR)CBO}$	$I_C=10\mu A$ $I_E=0$	50		V
Collector-emitter breakdown voltage	$V_{(BR)CEO}$	$I_C=10mA$ $I_B=0$	45		V
Emitter-base breakdown voltage	$V_{(BR)EBO}$	$I_E=1\mu A$ $I_C=0$	5		V
Collector cut-off current	I_{CBO}	$V_{CB}=45V$ $I_E=0$		0.1	μA
Collector cut-off current	I_{CEO}	$V_{CE}=40V$ $I_{BE(off)}=0$		0.2	μA
Emitter cut-off current	I_{EBO}	$V_{EB}=4V$ $I_C=0$		0.1	μA
DC current gain	h_{FE}	$V_{CE}=10V$ $I_C=150mA$	100 160 250	250 400 600	
Collector-emitter saturation voltage	$V_{CE(sat)}$	$I_C=500mA$ $I_B=50mA$		0.7	V
Base-emitter saturation voltage	$V_{BE(sat)}$	$I_C=500mA$ $I_B=50mA$		1.2	V
Transition frequency	f_T	$V_{CE}=5V$ $I_C=10mA$ $f=100MHz$	100		MHz

TYPICAL CHARACTERISTICS @ Ta=25°C unless otherwise specified

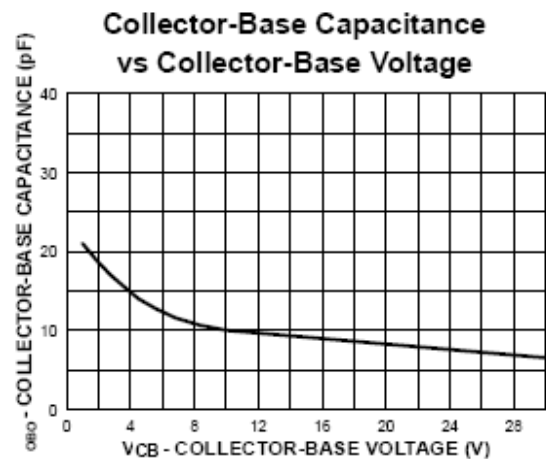
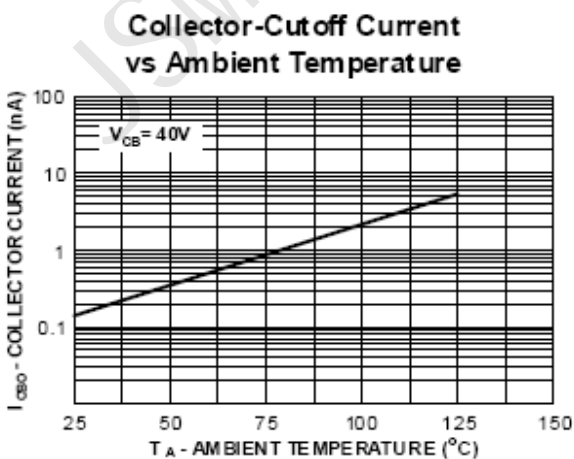
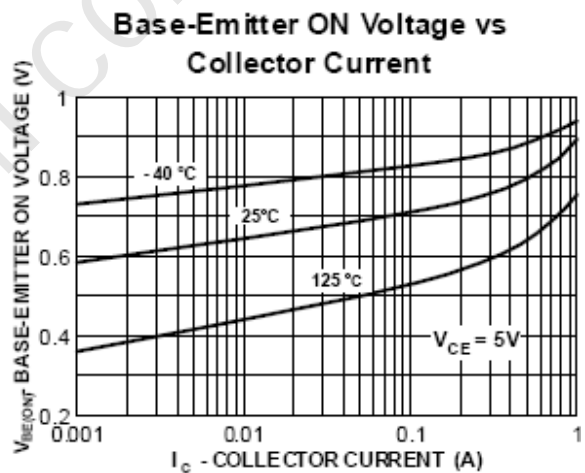
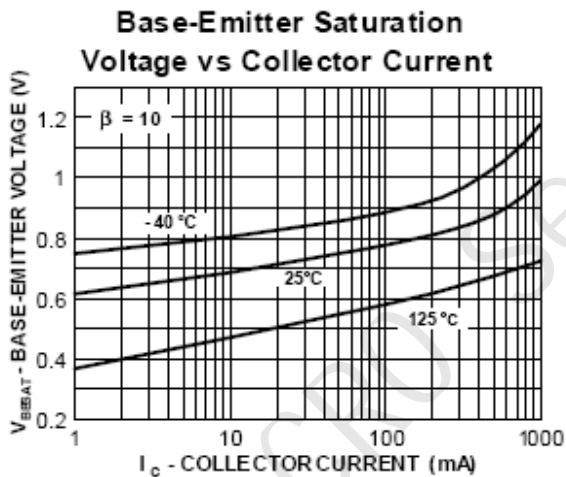
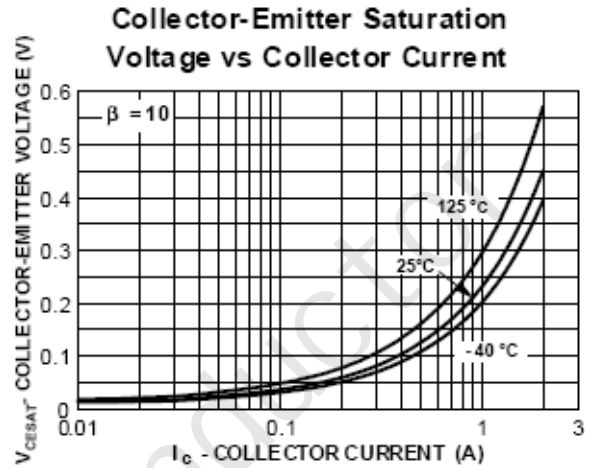
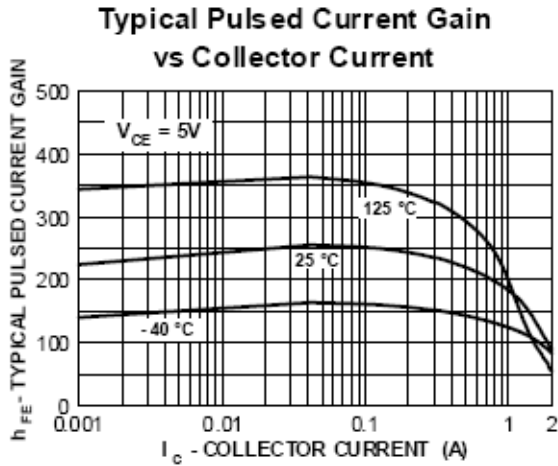

PACKAGE OUTLINE

Plastic surface mounted package

SOT-23

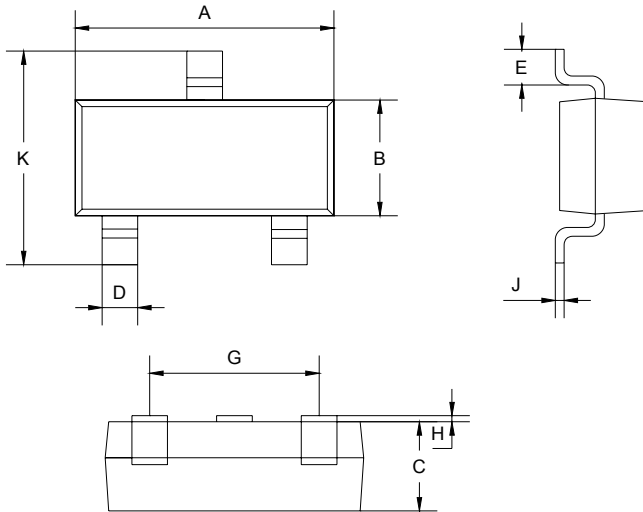

SOT-23		
Dim	Min	Max
A	2.85	2.95
B	1.25	1.35
C	1.0Typical	
D	0.37	0.43
E	0.35	0.48
G	1.85	1.95
H	0.02	0.1
J	0.1Typical	
K	2.35	2.45
All Dimensions in mm		

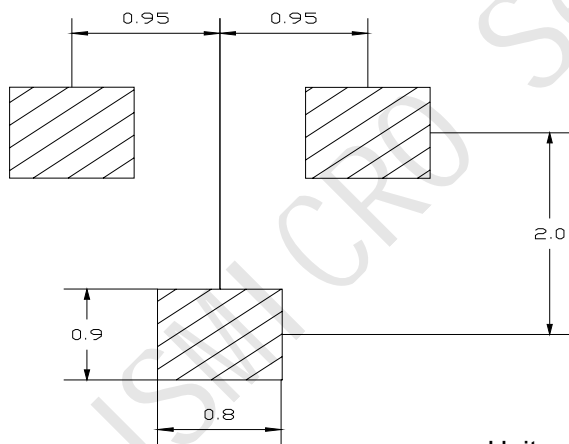
SOLDERING FOOTPRINT

Unit: mm

PACKAGE INFORMATION

Device	Package	Shipping
BC817-16/-25/-40	SOT-23	3000/Tape&Reel